



TOSHIBA

Leading Innovation >>>

AIR CONDITIONER (SPLIT TYPE)

Installation manual



Branch kit 1:2

Model name:

RBC-TWP101E

Installation manual
Air conditioner (Split type)

1

English

Manuel d'installation
Climatiseur (Type split)

14

Français

Please read this Installation Manual carefully before installing the Air Conditioner.

- This Manual describes the installation method of the indoor unit.
- For installation of the outdoor unit, follow the Installation Manual attached to the outdoor unit.

ADOPTION OF NEW REFRIGERANT

This Air Conditioner is a new type which adopts a new refrigerant HFC (R410A) instead of the conventional refrigerant R22 in order to prevent destruction of the ozone layer.

Contents

1	PRECAUTIONS FOR SAFETY	2
2	COMPONENT	5
3	REFRIGERANT PIPING	6
4	WIRING	9
5	PIPING HEAT INSULATION	13
6	TEST RUN	13
7	DELIVERY TO CUSTOMER	13

1 PRECAUTIONS FOR SAFETY

The two indoor units of TOSHIBA simultaneous twin packaged air conditioning system are the same units. Set and install the header and follower units taking the installation site into consideration. (Be certain to use the new refrigerant R410A in the indoor units.) The indoor unit connected to the remote controller will be the header unit.

- Ensure that all Local, National and International regulations are satisfied.
- Read indoor, outdoor installation manual and this manual carefully before Installation.
- The precautions described below include the important items regarding safety. Observe them without fail.
- After the installation work, perform a trial operation to check for any problem.
Follow the Owner's Manual to explain how to use and maintain the unit to the customer.
- Turn off the main power supply switch (or breaker) before the unit maintenance.
- Ask the customer to keep the Installation Manual together with the Owner's Manual.



WARNING

- **Ask an authorized dealer or qualified installation professional to install/maintain the air conditioner.**
Inappropriate installation may result in water leakage, electric shock or fire.
- **Turn off the main power supply switch or breaker before attempting any electrical work.**
Make sure all power switches are off. Failure to do so may cause electric shock.
- **Connect the connecting cable correctly.**
If the connecting cable is connected in a wrong way, electric parts may be damaged.
- **When moving the air conditioner for the installation into another place, be very careful not to enter any gaseous matter other than the specified refrigerant into the refrigeration cycle.**
If air or any other gas is mixed in the refrigerant, the gas pressure in the refrigeration cycle becomes abnormally high and it resultantly causes pipe burst and injuries on persons.
- **Do not modify this unit by removing any of the safety guards or by by-passing any of the safety interlock switches.**
- **Exposure of unit to water or other moisture before installation may cause a short-circuit of electrical parts.**
Do not store it in a wet basement or expose to rain or water.
- **After unpacking the units, examine them carefully if there are possible damage.**
- **Do not install in a place that might increase the vibration of the unit.**
- **To avoid personal injury (with sharp edges), be careful when handling parts.**
- **Perform installation work properly according to the Installation Manual.**
Inappropriate installation may result in water leakage, electric shock or fire.
- **When the air conditioner is installed in a small room, provide appropriate measures to ensure that the concentration of refrigerant leakage occur in the room does not exceed the critical level.**

- **Install the air conditioner securely in a location where the base can sustain the weight adequately.**
 - **Perform the specified installation work to guard against an earthquake.**
If the air conditioner is not installed appropriately, accidents may occur due to the falling unit.
 - **If refrigerant gas has leaked during the installation work, ventilate the room immediately.**
If the leaked refrigerant gas comes in contact with fire, noxious gas may generate.
 - **After the installation work, confirm that refrigerant gas does not leak.**
If refrigerant gas leaks into the room and flows near a fire source, such as a cooking range, noxious gas might generate.
 - **Electrical work must be performed by a qualified electrician in accordance with the Installation Manual. Make sure the air conditioner uses an exclusive power supply.**
An insufficient power supply capacity or inappropriate installation may cause fire.
 - **Use the specified cables for wiring connect the terminals securely fix. To prevent external forces applied to the terminals from affecting the terminals.**
 - **Conform to the regulations of the local electric company when wiring the power supply.**
Inappropriate grounding may cause electric shock.
 - **Do not install the air conditioner in a location subject to a risk of exposure to a combustible gas.**
If a combustible gas leaks, and stays around the unit, a fire may occur.
-



CAUTION

New Refrigerant Air conditioner Installation

- **THIS AIR CONDITIONER ADOPTS THE NEW HFC REFRIGERANT (R410A) WHICH DOES NOT DESTROY OZONE LAYER.**
- The characteristics of R410A refrigerant are; easy to absorb water, oxidizing membrane or oil, and its pressure is approx. 1.6 times higher than that of refrigerant R22. Accompanied with the new refrigerant, refrigerating oil has also been changed. Therefore, during installation work, be sure that water, dust, former refrigerant, or refrigerating oil does not enter the refrigerating cycle.
- To prevent charging an incorrect refrigerant and refrigerating oil, the sizes of connecting sections of charging port of the outdoor unit and installation tools are changed from those for the conventional refrigerant.
- Accordingly the exclusive tools are required for the new refrigerant. (R410A)
- For connecting pipes, use new and clean piping designed for R410A, and please care so that water or dust does not enter. Moreover, do not use the existing piping because there are problems with pressure-resistance force and impurity in it.
- The two indoor units of TOSHIBA simultaneous twin packaged air conditioning system are the same units.

- Set and install the header and follower units taking the installation site into consideration.
(Be certain to use the new refrigerant R410A in the indoor units.)
The indoor unit connected to the remote controller will be the main unit.

Wiring



- **TO DISCONNECT THE APPLIANCE FROM MAIN POWER SUPPLY.**
- This appliance must be connected to the main supply by means of a switch with a contact separation of at least 3 mm.
- The remote controller cannot be connected to both of the two indoor units (header and follower units).
Connect it only to the indoor unit that will become the header indoor unit (Unit A).
Connecting the remote controller to the follower indoor unit will cause malfunction.

Refrigerant Piping (Branch piping system is used for refrigerant piping)

- Compared with R22, pressure of R410A is about 1.6 times. Unless the piping is installed correctly, gas leak may be caused during operation such as pressure boosting. Conduct a leak test of the pipe connecting parts correctly.
 - In case the actual length of the piping exceeds the standard piping length, accurately add the refrigerant referring to Additional Refrigerant Amount.
 - Heat insulation materials for the branch pipes are not supplied as accessories. Provide heat insulation correctly using fitting covers or other materials sold on the market. For further information, read Refrigerant Piping and Piping heat Insulation on this manual. Improper heat insulation work will result in a failure and a claim.
-

2 COMPONENT

The following parts are supplied as accessories of the branch pipes. Check them when opening the carton box.

Part		Quantity	Shape	Use
Installation manual		5	This booklet	For installation works
Branch pipe	Gas side	1		Ø25.4 mm – Ø15.9 mm, Ø15.9 mm
		1		Ø25.4 mm – Ø28.6 mm (Inner diameter)
	Liquid side	1		Ø12.7 mm – Ø9.5 mm, Ø9.5 mm

3 REFRIGERANT PIPING

■ Tolerance of pipe length and Height difference

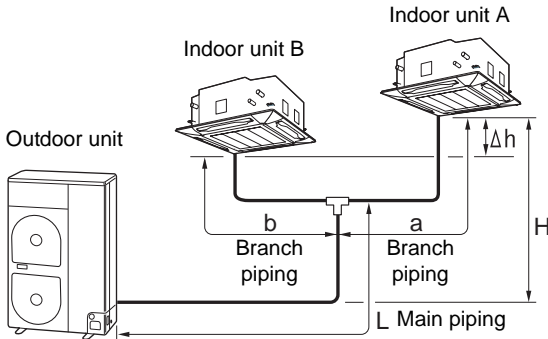

Model (RAV-)		SM224, SM280
Pipe Length (One Direction)	Full length ($L + a$ or $L + b$)	
	Branch piping (a, b)	
	Difference of branch piping length ($b - a$, or $a - b$)	
Height Difference	Outdoor Unit - Indoor Unit (H)	Outdoor Unit Installed Above Indoor Unit
		Outdoor Unit Installed Below Indoor Unit
	Between Indoor Units (Δh)	
Remarks		Less than 10 bends

EN

* Ensure that the shortest pipe length complies with the following:

$$L + b \geq 7.5 \text{ m}$$

$$a \geq b$$

⚠ CAUTION

When planning a layout for Units A and B, comply with the following:

1. The lengths after branching ("a" and "b") should be equal if feasible. Install Units A and B so that the difference of the branching lengths becomes less than 10 m if the lengths cannot be equal due to the branch pipe position.
2. Install Units A and B on the same level. If Units A and B cannot be installed on the same level, the difference in level should be limited to 0.5 m or less.
3. Be certain to install Units A and B in the same room. Units A and B cannot be operated independently each other.

■ Piping materials and sizes

Use general copper pipes with a wall thickness of 0.8 mm for Ø6.4 mm, Ø9.5 mm, and Ø12.7 mm, with a wall thickness of 1.0 mm for Ø15.9 mm, with a wall thickness of 1.2 mm for Ø19.1 mm, and with a wall thickness of 1.0 mm for Ø28.6 mm (half hard).

Do not use any copper pipes with a wall thickness less than these thicknesses.

In parentheses () are wall thickness

Model (RAV-)			SM224, SM280
Pipe side	Gas side	Main piping	Ø28.6 (half hard 1.0)
		Branch piping	Ø15.9 (1.0)
	Liquid side	Main piping	Ø12.7 (0.8)
		Branch piping	Ø9.5 (0.8)

■ Branch pipe

Now the refrigerant pipe is installed using branch pipes supplied as accessories.

- Bend and adjust the refrigerant piping so that the branch pipes and pipe after branching become horizontal.
- Fix the branch pipes onto a wall in a ceiling or onto a column.
- Provide a straight pipe longer than 500 mm in length as the main piping of the branches.

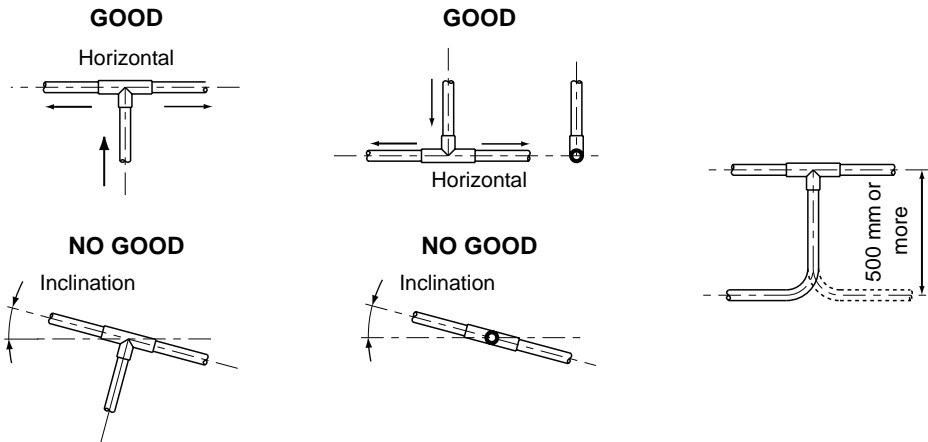

■ Air Purging

For the complete information, read the installation manual for outdoor units of air conditioner.

■ Additional Refrigerant Amount

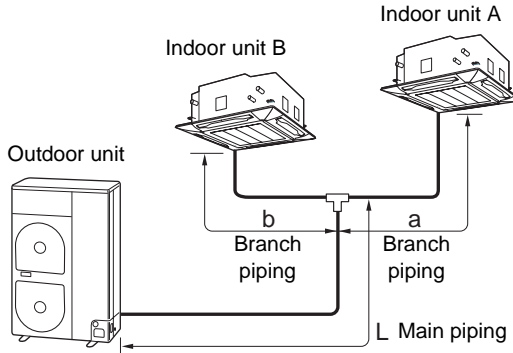

Formula for Calculating Additional Refrigerant Amount

Do not remove the refrigerant even if the additional refrigerant amount becomes minus result as a result of calculations by the following formula and operate the air conditioner as it is.

EN

$\begin{aligned} \text{Additional refrigerant amount (kg)} &= \text{Main piping additional refrigerant amount (kg)} + \\ &\quad \text{Branch piping additional refrigerant amount (kg)} \\ &= A \times (L - 28) + B \times (a + b - 4) \end{aligned}$

A: Additional refrigerant amount per meter of actual main piping length (kg)

B: Additional refrigerant amount per meter of actual branch piping length (kg)

L: Actual length of main piping (m)

a, b: Actual length of branch piping (m)

	Standard piping length		Additional refrigerant amount per Meter (kg/m)	
	Main piping	Branch piping	A	B
SM224 SM280	28 m	2 m	0.080	0.040



CAUTION

1. Be certain to write the additional refrigerant amount, pipe length (actual length), head and other specification on the nameplate put on the outdoor unit for recording.
2. Seal the correct amount of additional refrigerant in the system.

■ Gas Leak Test

- Use a leak detector manufactured specially for the HFC refrigerant (R410A, R134a, etc.) when testing R410A.

The sensitivity of leak detectors for previous HCFC refrigerants (such as R22) lowers to about 1/40 when used with HFC refrigerants and these detectors cannot be used.

4 WIRING

1. **Using the specified cables, ensure to connect the wires, and fix wires securely so that the external tension to the cables do not affect the connecting part of the terminals.**

Incomplete connection or fixation may cause a fire, etc.

Be certain to install wires by connecting them to terminals of the same numbers according to the following wiring diagram.

2. **Be sure to connect earth wire. (Grounding work)**

Do not connect the earth wire to gas pipe, city water pipe, lightning rod, or the earth wire of telephone.

Incomplete grounding causes an electrical shock.

3. **For electric work, strictly follow the Local Regulation in each country, Indoor, outdoor, and this Installation Manual, and use an exclusive circuit.**

Capacity shortage of power circuit or incomplete installation may cause an electrical shock or a fire.

■ Internal And External Connection Wiring

1. Install wires from the outdoor unit to the header unit as in usual wiring.
(Wires (1), (2), (3) and ground wire.)
2. Install wires (1), (2) and ground wire only when installing connection wires from the header unit to the follower unit.

■ Remote Controller wiring

1. Installing connection shield wires (MVVS 0.5 to 2.0 mm²) from the header unit to the follower unit to conform to EMC standard.
2. Install shield wires between the header unit and follower unit. The shield wires of the remote controller have no polarities.
The remote controller circuits are low voltage circuits. These circuits must not be made to directly contact internal and external wires or contained in the same conduit tubes that house internal and external wires.
(Otherwise malfunction will be caused by noise)

■ Wiring Diagram

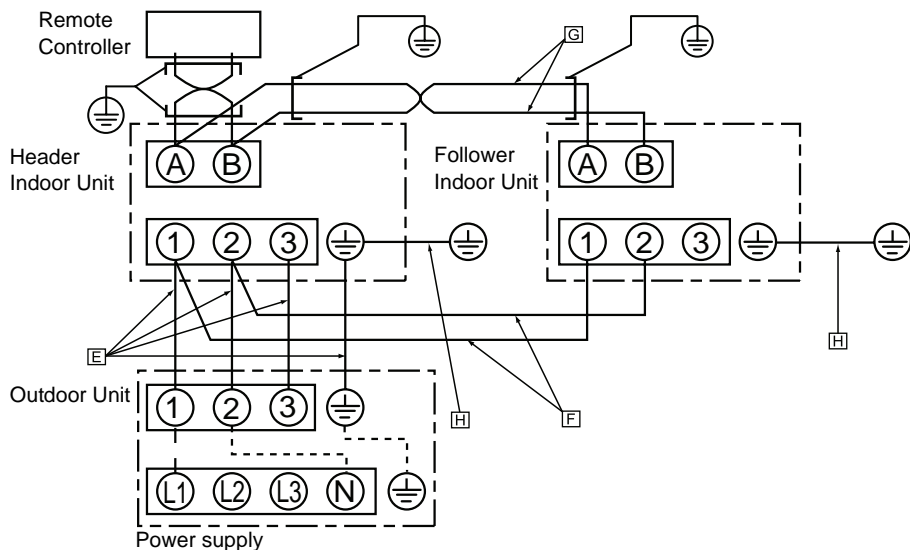

REQUIREMENT

- The remote controller wiring has no polarity. Connections to terminals A and B of an indoor unit may be replaced with each other.
- The remote controller wires and indoor-indoor connecting wire must not be in direct contact or in the same conduit pipe. (Doing so may cause a malfunction of the control system due to noise.)

■ Wiring Specification

Specification of Wires Between Units and Numbers of Wires.

Outdoor unit - indoor unit (header unit) [E]	No. of wires	4 (Include ground wire)
	Wire diameter	H07RN-F or 60245IEC66 1.5 mm ² or more
Indoor unit - indoor unit (header unit) (follower unit) [F]	No. of wires	2
	Wire diameter	H07RN-F or 60245IEC66 1.5 mm ² or more
Remote controller wiring [G]	No. of wires	2 (Shield wire)
	Wire diameter	Between 0.5 mm ² and 2 mm ² (up to 200 m)
Grounding wire of indoor unit [H]		H07RN-F or 60245IEC66 1.5 mm ² or more

Procure necessary parts and perform all connection work locally.

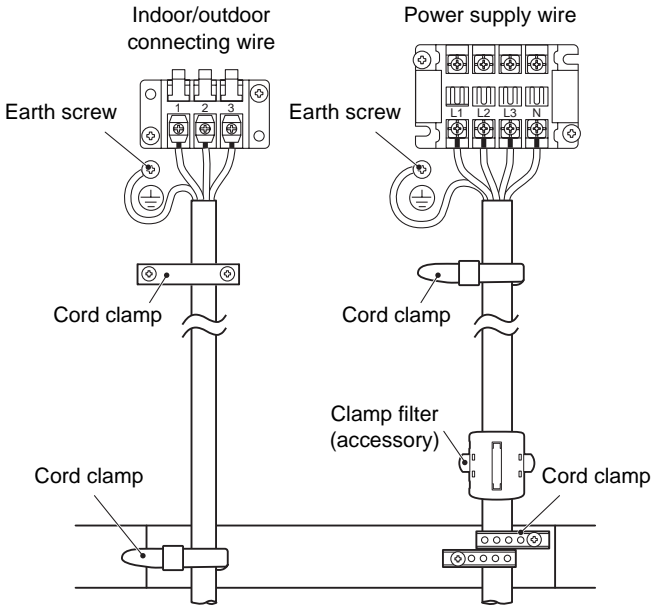

⚠ WARNING

Be sure to attach the provided clamp filter to the power supply wire in order to conform to EMC standards.

Stripping length power cord and connecting wire

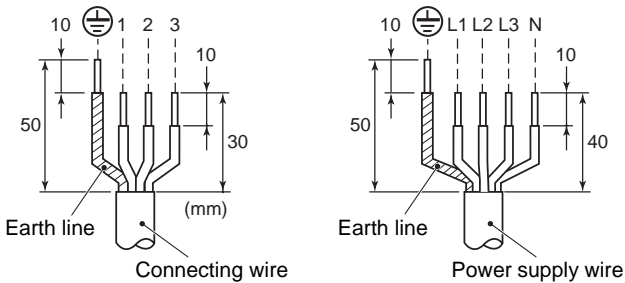

NOTE

When using the equipment at the first time, it will take a lot of time that the remote controller accepts an operation after power was on. However, it is not a trouble.

Automatic address

While automatic addressing, the operation can not be performed on the remote controller.

- For automatic addressing, Max. 10 minutes (generally, approx. 5 minutes) are required.

When power will be turned on after finish of automatic addressing;

- It will require Max. 10 minutes (generally, approx. 3 minutes) that outdoor unit starts operation after power was on.
-

5 PIPING HEAT INSULATION

Thermal insulation was produced locally.

Be certain to thermally insulate the piping both on the liquid and gas sides.

- Use thermal insulating materials for piping higher than 120 degree in heat resistance.
Example: EPT - Ethylene, propylene, terpolymer
- Thermally insulate the branch pipe sections using fitting covers (for tees) more than 10 mm in thickness or processing thermal insulation materials as follows.
(Thermal insulation materials for the branch pipes are not supplied as accessories.)
- Seal the branch pipe sections tightly without producing gaps.

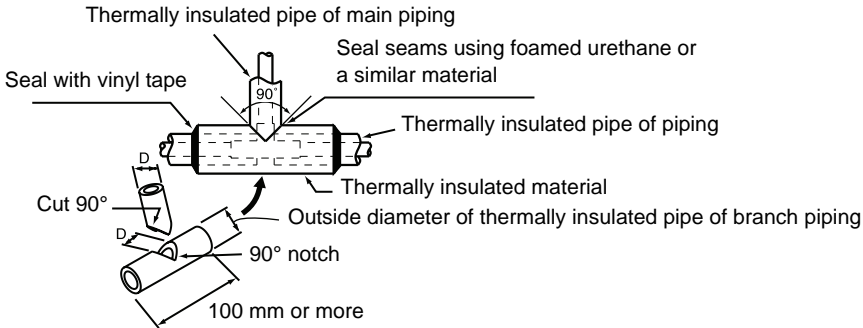

6 TEST RUN

Be certain to conduct a test run in accordance with the procedures contained in the operating and installation manual supplied with the indoor units.

7 DELIVERY TO CUSTOMER

- Make certain to hand over the instruction manual supplied with the indoor units to the customer.
- Deliver the system after thoroughly explaining the contents of the instruction manual. It is important to explain to the customer in details about simultaneously starting and stopping the two indoor units by operating one remote controller.

