

Ver.

| - -

„ORIGINAL INSTRUCTIONS“

IMPORTANT NOTE:

Read this manual carefully before installing or operating your new air conditioning unit. Make sure to save this manual for future reference.

EN

For downloading manual for this product, please enter the model name at this link:

**SK**

Pre stiahnutie manuálu k tomuto produktu zadajte modelové označenie do nasledujúceho odkazu:

**HR**

Za preuzimanje priručnika za ovaj proizvod unesite naziv modela na ovu vezu:

**SL**

Za prenos navodil za uporabo tega izdelka, vnesite ime modela na tej povezavi:

**IT**

Per scaricare il manuale di questo prodotto, inserisci il nome del modello a questo link:

**CZ**

Pro stažení manuálu k tomuto produktu zadejte modelové označení do následujícího odkazu:

**DE**

Um das Handbuch für dieses Produkt herunterzuladen, geben Sie bitte den Modellnamen für diesen Link ein:

**HU**

Termék kézikönyvének letöltéséhez írja be a modell megnevezését az alábbi linkre:

**RU**

Чтобы загрузить руководство для этого продукта, введите обозначение модели по следующей ссылке:

**ES**

Para descargar el manual de este producto, ingrese la designación del modelo en el siguiente enlace:







To Users

Thank you for selecting Sinclair's product. Please read this instruction manual carefully before installing and using the product, so as to master and correctly use the product. In order to guide you to correctly install and use our product and achieve expected operating effect, we hereby instruct as below:

- (1) This appliance is not intended for use by persons (including children) with reduced physical, sensory or mental capabilities, or lack of experience and knowledge, unless they have been given supervision or instruction concerning use of the appliance by a person responsible for their safety. Children should be supervised to ensure that they do not play with the appliance.
- (2) This instruction manual is a universal manual, some functions are only applicable to particular product. All the illustrations and information in the instruction manual are only for reference, and control interface should be subject to actual operation.
- (3) In order to make the product better, we will continuously conduct improvement and innovation. We have the right to make necessary revision to the product from time to time due to the reason of sales or production, and reserve the right to revise the contents without further notice.
- (4) For personal injury or property loss and damage caused by improper operation such as improper installation and debugging, unnecessary maintenance, violation of related national laws and rules and industrial standard, and violation of this instruction manual, etc., we will bear no liability.
- (5) The final right to interpret for this instruction manual belongs to SINCLAIR CORPORATION Ltd.

1 Safety Notices (Please be sure to abide)

	Warning: If not abide strictly, it may cause severe damage to the unit or the people.
	Note: If not abide strictly, it may cause slight or medium damage to the unit or the people.
	This sign indicates that the operation must be prohibited. Improper operation may cause severe damage or death to people.
	This sign indicates that the items must be observed. Improper operation may cause damage to people or property.



WARNING!

This product can't be installed at corrosive, inflammable or explosive environment or the place with special requirements, such as kitchen. Otherwise, it will affect the normal operation or shorten the service life of the unit, or even cause fire hazard or serious injury. As for above special places, please adopt special product with anti-corrosive or anti-explosion function.

2 User Notice

- (1) All indoor units must be supplied with unified power.
- (2) Make sure communication cord is connected with the proper port, otherwise there may occur communication malfunction.
- (3) Never knock on, throw or frequently detach the centralized controller.
- (4) Never operate the centralized controller with wet hands.
- (5) Never scratch the screen of centralized controller by hard or sharp objects.
- (6) If the centralized controller is connected with the outdoor network or the last indoor unit of the indoor network, then a matching resistance must be connected between A3 and B3 ports.
- (7) the centralized controller Connect with UNI SPLIT or MULTI VARIABLE unit, The indoor unit address must be set within the range from 1 to 36, communication way of UNI SPLIT or MULTI VARIABLE unit set long-distance monitoring mode

3 INSTALLATION

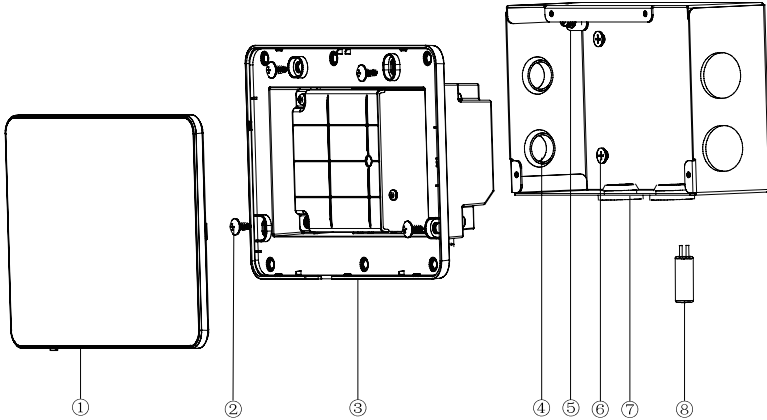

Figure 3-1 Parts of Centralized Controller

No.	①	②	③	④
Name	Touch screen	Self-tapping screw ST4.2×9.5 MC (used to secure the rear cover of controller)	Rear cover of controller	Rubber band
QTY	1	4	1	6
No.	⑤	⑥	⑦	⑧
Name	Screw M4×12 (used to secure earthing wire)	Screw ST4.2×16 FA (used to secure electric box cover)	Electric box cover	Matching resistance 150 Ω
QTY	1	4	1	2

Unit : mm

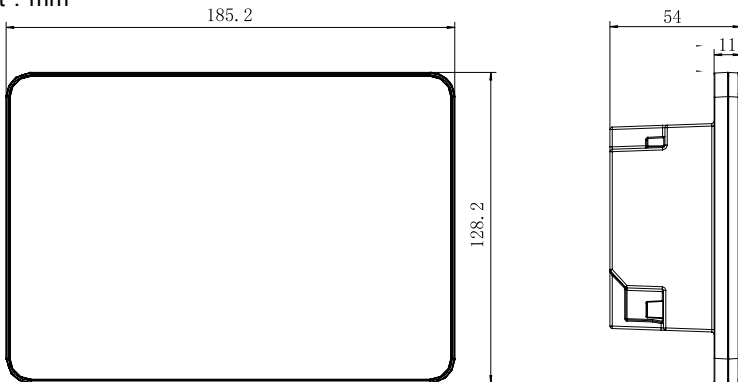

Figure 3-2 Dimension of Centralized Controller

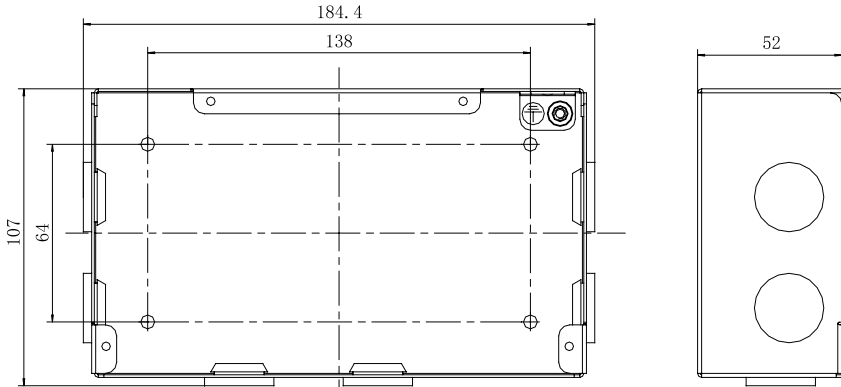

Figure 3-3 Dimension of Electric Box Cover

3.1 Installation Requirements

(1) Communication cord of the centralized controller

must be selected according to the table below. Never use the cable that is not in compliance with instructions of this manual.

Network	Cord type	Cord standard	Cord size (mm ² /AWG)	Total length L (m/feet)	Remark
Indoor network	Light/ Ordinary polyvinyl chloride sheathed cord. (60227 IEC 52 /60227 IEC 53)	IEC 60227-5:2007	2×0.75~2×1.25 (2× AW G18~2×A WG16)	L≤1000m (L≤3280-5/6feet)	If cord size is 2×1mm ² (2×AWG16), communication cord can be stretched longer. But the total length can't exceed 1500m (4921-1/4feet).
Outdoor network				L≤500 (L≤820-1/5feet)	Total length of communication cord can't exceed 500m (820-1/5feet).

Notice:

- 1) The cord shall be Circular cord (the cores shall be twisted together).
 - 2) If unit is installed in places with intense magnetic field or strong interference, it is necessary to use shielded wire
- (2) Communication cord of the centralized controller and L-CAC&Split unit (Modbus net) must be selected according to the table below

Cord type	Cord size (mm ²)	Cord standard	Note
Two_core twisted pair	24AWG (2×0.6mm)	TIA/EIA-568-A	When the communication distance exceeds 800m, the need to increase the photoelectric isolation repeater

- (3) Never install the centralized controller in the following places:
- 1) Places with corrosive gas or serious dust, salt mist or oil smoke.
 - 2) Wet and damp places, with direct sunlight.
 - 3) Places near high temperature objects or places where units might be splashed by water.

3.2 Wiring Instructions

3.2.1 Wiring Ports

Port print	G1, G2	F1, F2	A2, B2	A3, B3	L, N
Meaning	CAN comm. port	fire alarm port	【reserved port】	L-CAC&Split Unit port	Power port

3.2.2 Power Supply

- (1) The centralized controller shall use independent power supply.
- (2) The range of input voltage: 100 ~ 240 VAC; Frequency range: 50/60Hz
- (3) Select power cord according to the following table. Never use the power cord that is not in compliance with instructions of this manual.

Cord type	Cord standard	Cord size (mm ²)
Single-cord soft conductiveunsheathed cord (60227 IEC 08)	IEC 60227-3:2007	1.5

3.2.3 Connection Method of L-CAC&Split unit (Modbus network)

The central controller has two ways to connect with the system:

Method 1 : The centralized controller Connect with UNI SPLIT Unit
(Modbusnetwork) according to the below.

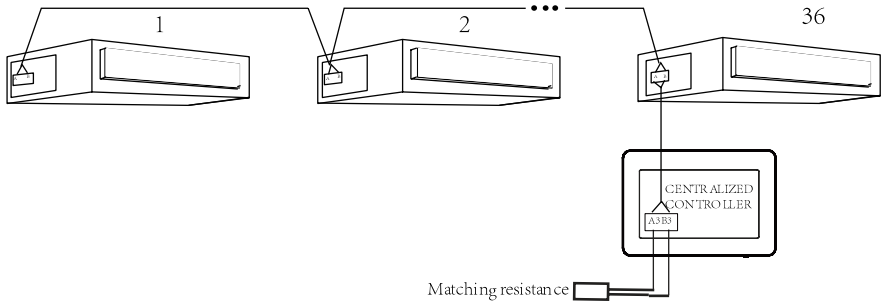

Figure 3-7 Centralized Controller Connected with UNI SPLIT Unit

Wiring Instructions:

(1) The centralized controller is applicable to UNI SPLIT units, One centralized controller can control up to 36 UNI SPLIT units.

(2) If the centralized controller is to be connected with UNI SPLIT units, connect according to fig.3-7. The controller must connect with terminal unit of UNI SPLIT system .Connect the centralized controller's A3 and B3 ports to

COM_BMS port on the UNI SPLIT unit correspondingly with communication cords. A matching resistance needs to be added with the communicationcords at the A3 and B3 ports. There are two COM_BMS ports (two coreneilsbed and no polarity) on mainboard of UNI SPLIT unit, one for centralized controller and another for UNI SPLIT unit connection.

Note: If the centralized controller is to be connected with UNI SPLIT units , communication line (one end is two-core terminal, the other end is the bare wire. Code :420400060252) need to be purchased separately. The quantity of communication line is the quantity of indoor units plus 1.

(3) The indoor unit address must be set within the range from 1 to 36, and different from each other. Identical addresses will lead to communication failure. Below is the address setting method:

- 1) Under OFF status, press “Function” and “Mode” on the wired controller simultaneously for 5S to enter the address setting. Then the display panel will show its own address number on the temperature display zone. Adjust the number by pressing the “Up” and “Down” buttons.
- 2) When setting is over, press “OK/Cancel” or “Swing/Enter” to save the setting and exit. Under the setting status, if no action is taken within 20 seconds, system will exit from the setting and return to the display mode of OFF status. Setting can't be saved in this case.

(4) Communication method of UNI SPLIT units must be long-distance monitoring mode, else can not communicate with centralized controller, set the way as follows.

- 1) Under OFF status, press “Function” and “Timer” on the wired controller simultaneously for 5S to enter the setting of long-distance monitor. Adjust by pressing the “Up” and “Down” buttons.
- 2) When setting is over, press “OK/Cancel” or “Swing/Enter” to save the setting and exit. Under the setting status, if no action is taken within 20 seconds, system will exit from the setting and return to the display mode of OFF status. Setting can't be saved in this case.

Note: Address setting and long-distance monitor setting of units can only be achieved through wired controllers.

Method 2: The central controller connects to the MULTI VARIABLE by the method asbelow:

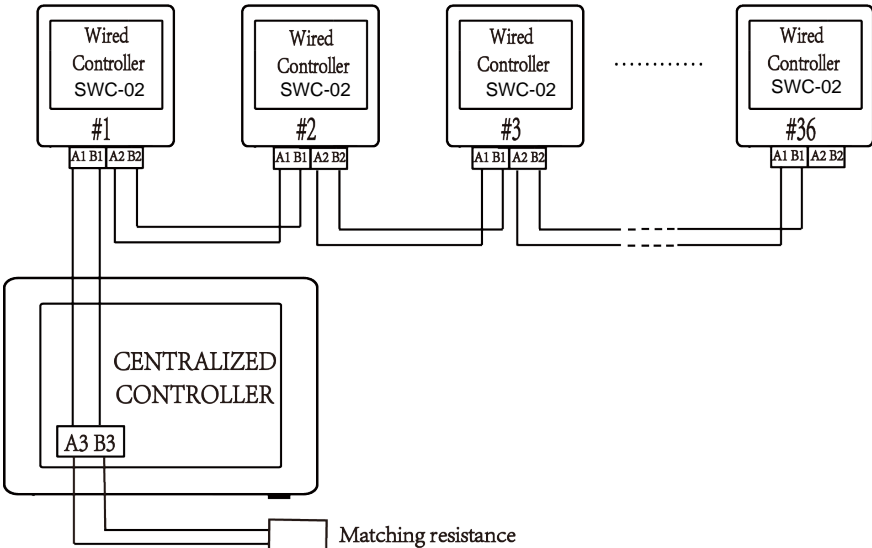

Figure 3-8 Centralized Controller Connected with Wired Controller SWC-02

Wiring Instructions:

- (1) The connection sketch map of control system is shown by the fig. 3–8. The complete control system is composed of long-distance central controller, wired controller SWC-02 and telecommunication cable. The wired controller SWC-02 matched with long-distance central controller can support 36 addresses of communication node at the most.

Note:

If the centralized controller is to be connected with Wired Controller SWC-02 communication line (one end is two-core terminal, the other end is the bare wire. Code: 420400060252) need to be purchased separately. The quantity of communication line is the two-times quantity of Wired Controller SWC-02.

- (2) Wiring terminals of port A3 and port B3 of the central controller or the long distance controller connect to the corresponding terminal of communication needle stand of #1 wired controller through the telecommunication cable respectively; the other needle stand of #1 wired controller connects to the #2 wired controller through the telecommunication cable and so forth until connect to the #36 wired controller. Except the last

wired controller in the control system (only use CN3 or CN4, and the other one will not be connected), there's no the sequence and the importance for the wired controller. The series number in the figure is only for the sake of clarity.

(3) There is a 2-bit DIP switch on the main board of wired controller SWC-02. As for the last #36 wired controller in the control system, the 1-bit and the 2-bit of the DIP switch should be manually pulled to position "on" and position "off"

respectively. The DIP switches of other wired controllers should be kept at the initial ex-factory status (1-bit and 2-bit are set at position "off")

(4) As for the complete control system, the distance from the long-distance central controller to the communication cable of the last communication node should be less than 500m.

Note:

UNI SPLIT units and MULTI VARIABLE units can be mixed to connected with centralized controller. The quantity is less than 36

3.3 Installation Procedure

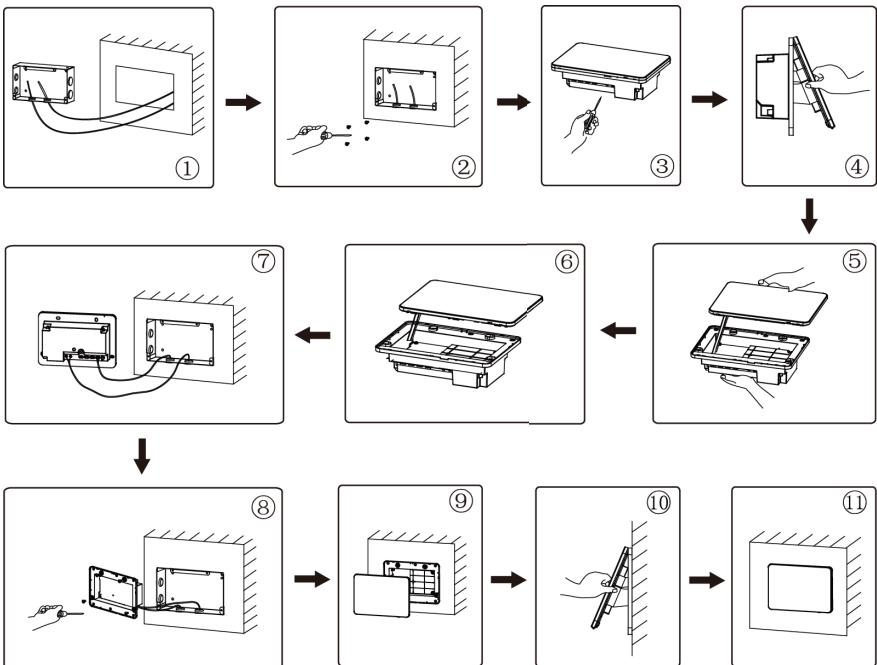

Figure 3-9 Installation Diagram

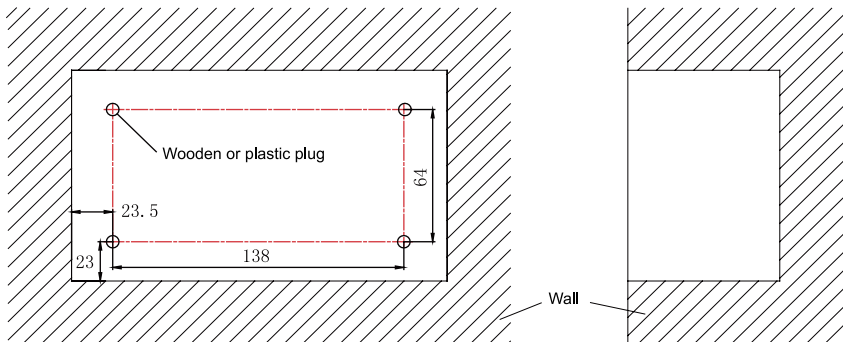

Figure 3-10 Diagram of Wooden or Plastic Plug

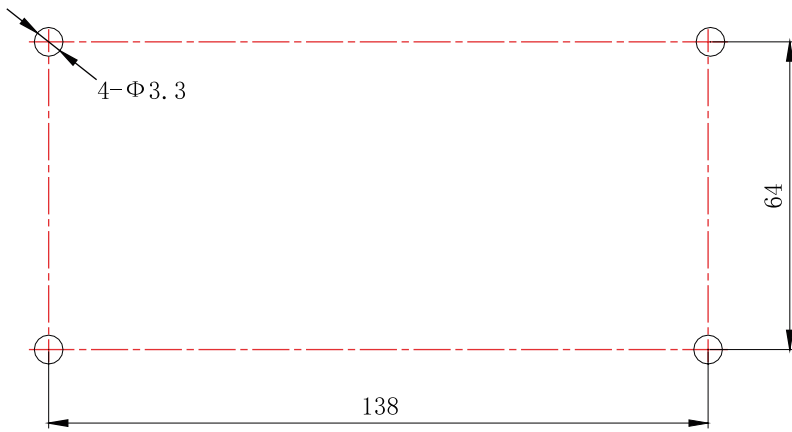



Figure 3-11 Installation Holes of the Electric Box Rear Cover

fig.3-9 is a simple installation procedure of centralized controller. Please pay attention to the following matters:

- (1) Before installation, first cut off the power supply of indoor unit. The power must be cut off during the whole installation process.
- (2) During the installation, be careful not to damage to touch screen.
- (3) Before installation, please make the following preparations:
 - 1) In case that the centralized controller is installed on wall, dig a hole that is the size of 180mm×107mm×62mm and peg 4 wooden or plastic plugs on the wall according to fig.3-10.
 - 2) In case that the centralized controller is installed inside the control cabinet, dig 4 installation holes on the surface of the control cabinet according to fig.3-11.

- (3) In step ①, pull out the power core and communication cord, and then lead them separately from the wire orifice of the electric box rear cover. Never lead the cords through a same orifice.
- (4) In step ⑥ pull out the wire connecting the touch screen and controller's rear cover. Put the touch screen on a safe place.
- (5) In step ⑦, connect the communication cords to A3,B3 terminals, and connect the neutral wire and live wire to the N, L terminal; connect the ground wire to position on the electric box rear cover. Secure it with screw M4×12.
- (6) In step ⑧, locate the controller's rear cover onto the electric box rear cover with screw ST4.2×9.5 TC. 
- (7) In step ⑨, connect the wire between touch screen and controller's rear cover

3.4 Removal Procedure

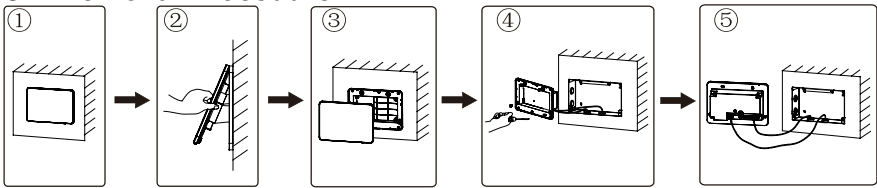

Figure 3-12 Diagram of Removal

4 DISPLAY AND WORKING INSTRUCTIONS

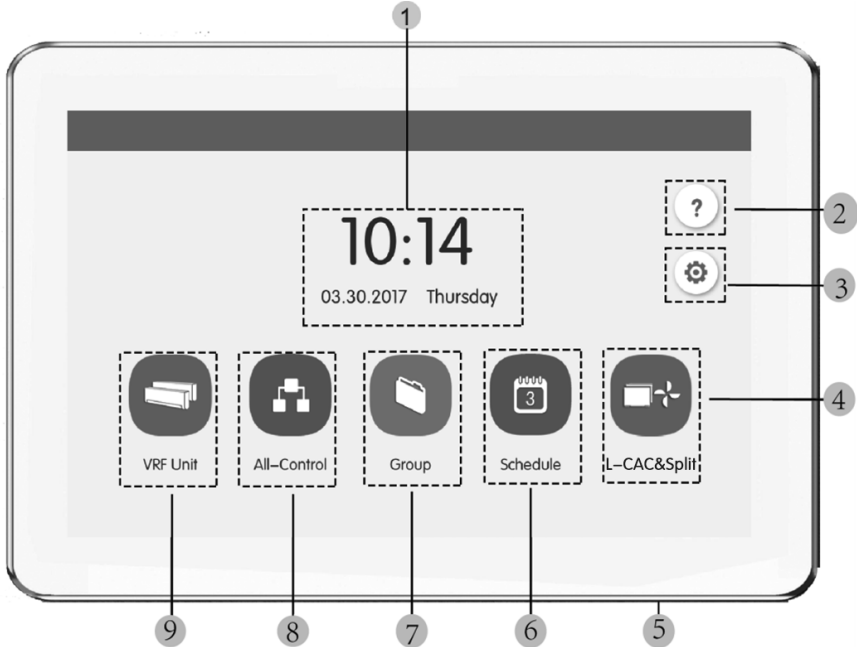





















Figure 4-1 Main Page

4.1 Main Page Display and Buttons

No.	Name	Instructions
1	Time zone	The present date, week and time
2	Help button 	Press this button to enter Help Info page
3	Setting button 	Press this button to enter setting page
4	Single-Control button 	Press this button to enter UNI SPLIT or MULTI VARIABLE unit page
5	Touch button	Press the Touch Button to turn on/off the screen of centralized controller. Press and hold the Touch Button for 5sec to restart to centralized controller.
6	Schedule button 	Press this button to enter schedule page

7	Group button 	Press this button to enter group page
8	All-Control button 	Press this button to enter All-Control page

4.2 General Buttons

Display	Name	Meaning	Display	Name	Meaning
	Return	Press this button to return to the previous page		Cancel	Press this button to cancel the current setting and return to the previous page
	Save	Press this button to save the current setting and return to the previous page		Add	Press this button to add schedule
	Group Control	Press this button to enter Group control page		IDU Sort	Press this button to enter IDU sort page
	Edit	Press this button to edit the group or schedule		Delete	Press this button to delete group or schedule
	Up	Press this button to increase value or select the previous option		Down	Press this button to decrease value or select the next option
	Left	Press this button to return back to previous page		Right	Press this button to the next page
	Forward Page Shift	On the IDU sort page, Press this button to move the selected IDU forward one page		Backward Page Shift	On the IDU sort page, Press this button to move the selected IDU backward one page

<	Forward Shift	On the IDU sort page, Press this button to move the selected IDU forward one place	>	Backward Shift	On the IDU sort page, Press this button to move the selected IDU backward one place
i	Info	Press this button to enter Info page		Shield	Press this button to conduct shield function of wired controller to nullify such operation

4.3 Buttons Working Instructions

The centralized controller uses a capacitive touch screen so that user can operate the units by just touching the screen.

Buttons on the screen are presented in the following ways:

(1) Icon

Icon button can be operated directly. See section 4.2 for more details.

(2) Icon + Text

According to the meaning of words, turn on or off or select a certain function, or enter a certain page. This type of button has 2 or 3 kinds of status based on the specific function.

Meaning of status (take Sleep Button as an example):



Thin light indicates invalid/not selectable. Sleep function is invalid and can't be selected. Different cases for models.



Light indicates off/not selected. Sleep function is off. Pressing the grey sleep button can turn on the sleep function.



Dark indicates on/selected. Sleep function is on. Pressing the orange sleep button can turn off the sleep function.

(3) Sliding

Sliding up/down to slide the group and setting page up&down.

(4) Sliding bar

Press and hold the sliding bar to drag up/down or left/right and to adjust the value. For example the backlight setting, etc.

(5) Zone button

On the management pages of schedule, as indicated in fig.4-2 (the home page of schedule), each rectangle frame constitutes a zone button.

Press the zone button, then the turning on/off of corresponding function or the corresponding page will pop in.

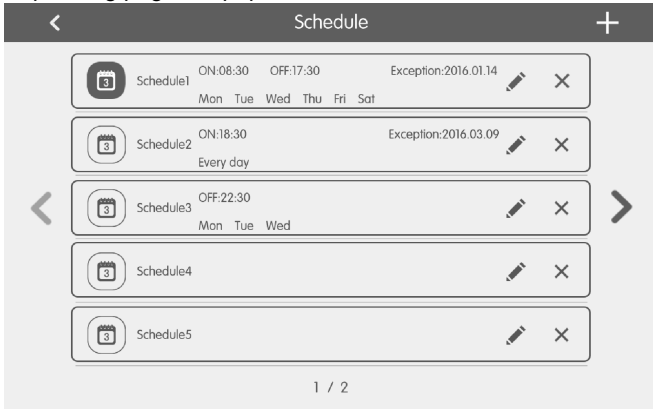

Figure 4-2 Zone Buttons on the Homepage of Schedule

5 FUNCTIONS DESCRIPTION

5.1 Help Info

On the homepage, press  to enter into help info page.

User can view the information of the simple operation manual.

5.2 All-Control Function

On the homepage, press  enter into the page of All-Control.



Figure 5-6 All-Control Page

All-Control Function can operate all indoor units as below :

(1) ON/OFF

Press ON/OFF button to turn on or turn off all units.

When turning off the unit, the setting for mode, temperature, fan speed and swing is unavailable.

(2) Mode setting

Press mode button to set operation mode.

(3) Temperature setting

Press UP or Down button to adjust temperature. Press this button once to increase or decrease temperature 1°C. Press or hold this button and the temperature will increase or decrease continuously.

(4) Fan speed setting

Press or drag the sliding bar of fan speed to set fan speed.

Note: Fan speed defaults at low speed under drying mode and it can't be adjusted.

(5) Swing setting

Press "left&right" swing or "up&down" swing button to turn on or turn off swing function.

(6) Send order

Press button ✓ to send out the All-Control order.

5.3 Schedule Management

On the homepage , press  button to enter into the page of schedule management.



Figure 5-8 Page of Schedule

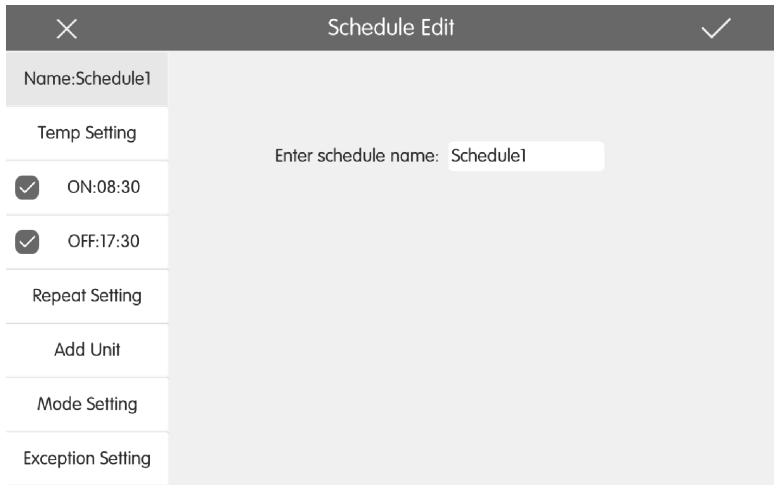

Figure 5-9 Page of Schedule Editing

(1) Open the schedule

Press the zone button to open or close the schedule.

When the icons and texts turn blue indicating the schedule is open.

When the icons and texts turn grey indicating the schedule is closed.

When schedule is open, centralized controller will send out the control order automatically according to the time and parameters set by the schedule.

(2) Edit schedule

Press  to enter the page of schedule editing.

Press  to enter the page of schedule editing.

1) Setting method of schedule control parameters is the same with that of the single indoor unit control.

2) Add equipment

Press the “Add Unit” button to enter the page of equipment selection. User may set the indoor unit that works according to the current schedule.

Note: schedule of Centralized Controller can add UNI SPLIT units. For a same indoor unit, different schedules can be set at the same time. In this case, unit will work according to the schedule setting that is previously energized.

3) Repeat schedule

Press “Repeat Setting” button to enter the setting page. User can set the schedule work repeatedly according to weeks.

4) Time setting

Press the “ON Time” or “OFF Time” button to enter the page of time setting.

User can set the time for unit to turn on/off automatically.

Note: The time to activate or stop unit can be set at the same time, but they must not be the same.

5) Add exception

Press the “Exception Setting” button to enter the setting page of schedule exception.

The calendar will pop in, user can select the date to activate or cancel exception. Press ✓ to save the selected date.

Notes: When schedule exception has been set, air conditioner will not execute the control order on the exception date set by the schedule.

User may add several exception dates.

(3) Add schedule

Press + to add new schedules. Then the schedule editing page will pop in for user to set relevant parameters.

Note: User may add up to 28 schedules.

(4) Delete schedule

Press ✕ to delete the selected schedule.

5.4 Single-Control

5.4.1 Unit Control

On the homepage, press  to enter the Control Page.

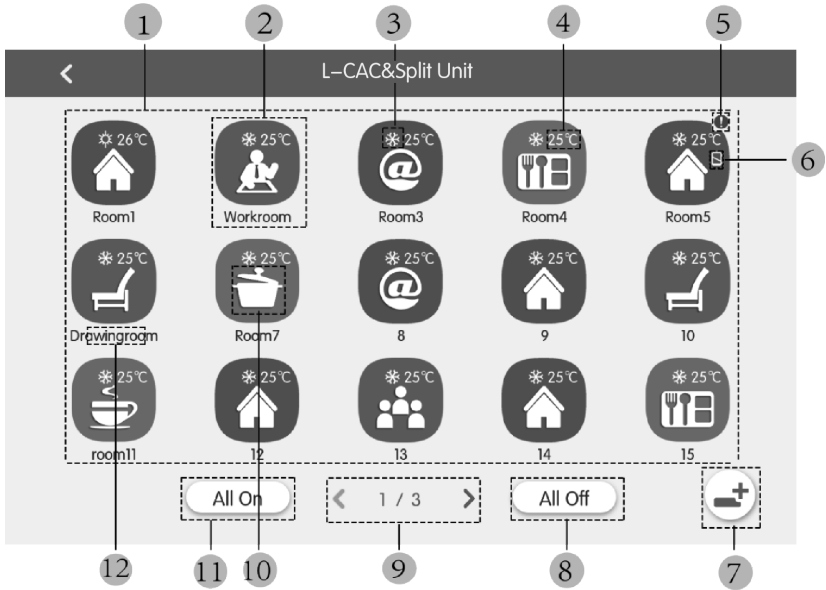

Figure 5-10 Single-Control homepage

No.	Name	Instructions
1	display zone	Display the list of units controlled by the central controller.
2	icon buttons	Press the button to enter the control page of a single unit. Bright icon indicates the corresponding unit is ON and dark icon indicates the corresponding unit is OFF Press and hold the icon to enter the page of name and icon settings.
3	Icon of running mode	When indoor unit is ON, its running mode will be displayed in the following way auto cool dry fan heat
4	Icon of set temperature	Display when the unit is ON. It means set temperature of the device.
5	Icon of malfunction	If the unit is with trouble, this icon will be shown.
6	Icon of shiedling status	If the unit is in shielding status, this icon will be shown.
7	registration icon	Press the icon to enter the registration page for the unit.
8	All off button	Press the icon to turn off all the units.
9	Page turning	Press this icon to turn pages.
10	All on button	Press the icon to turn on all the units. Then units will run according to memories.

11	unit icon	Display the current unit icon
12	unit name	Display the current unit name

Before using, press the registration icon and enter the registration page. Register theUNI SPLIT or MULTI VARIABLE units that are going to be controlled. Centralizedcontroller can support the control of 36 units at most.

Press and holdSingle-Control icon for 5S to enter the page of settings. Then you may set the name and icon for the unit.

UNI SPLIT and MULTI VARIABLE unit control parameters include general control parameters and advanced control parameters.

Note:

(1) when in the function of All-central control for UNI SPLIT or MULTI VARIABLE, all the units are controlled, but not controlled by advance setting.

5.4.2 General Control Parameters

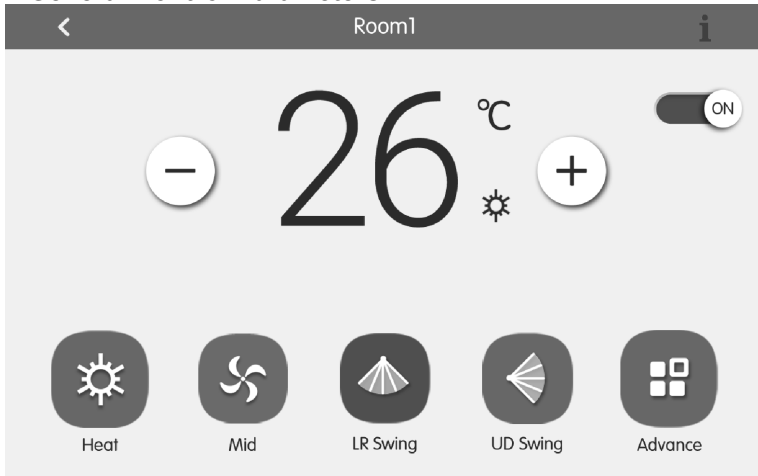

Figure 5-11 Control Page of Single UNI SPLIT unit

(1) ON/OFF

Press the on/off button to turn unit on or off.

When unit is turned off, mode, temperature, fan speed and swing can't be set.

(2) Mode setting

Press the Mode buttons to set UNI SPLIT unit operation mode. Modes for indoor units of different series are not all the same. If a certain mode is not available in the indoor unit, the icon of the corresponding mode cannot be selected.

Note:

- 1) Auto mode can only be set in the master indoor unit.
- 2) Heat recollection system have no master indoor unit. When the indoor unit of the same branch is connected into one indoor unit, the auto mode can be set; when the quantity of indoor unit in the same branch is more than one set, the auto mode cannot be set; other modes can be freely switched.

(3) Temperature setting

Press the up or down buttons to adjust temperature. Each time pressing the button will increase/decrease the temperature by 1. Holding down the button can increase/decrease temperature continuously.

Pressing the  button can display the "indoor temp" and "outdoor temp".

(4) Fan speed setting

Press the fan speed button to set UNI SPLIT unit fan speed.

Note: Unit defaults to low fan speed in drying mode. Fan speed cannot be set in drying or floor heating mode.

(5) Swing setting

Pressing the button "Up&Down Swing" or "Left&Right Swing" can turn on or off the swing function.

Note: Swing types for indoor units of different series are not all the same.

(6) Malfunction View

When indoor unit fails to function well, the  will turn red. then press the button to view the information of malfunctions.

5.4.3 Advanced Control Parameters

Press the advanced button to enter the advanced page.

Press the icons to turn on or off related functions.

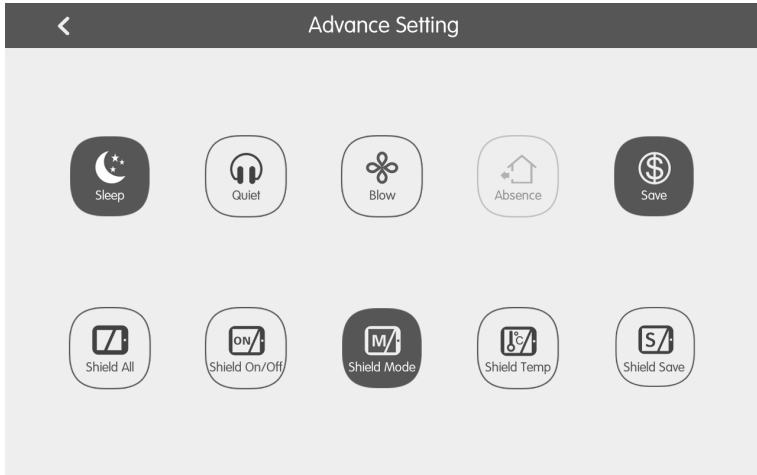

Figure 5-12 advanced page

- (1) The functions of Sleep, Quiet, Blow, Absence, Energy Saving are only effective under ON status.
- (2) Absence function can only be enabled in Heat mode. When Absence function is enabled, set temperature is 8°C.
- (3) When All Shield function is enabled, other shield buttons are ineffective.

5.5 Local Setting

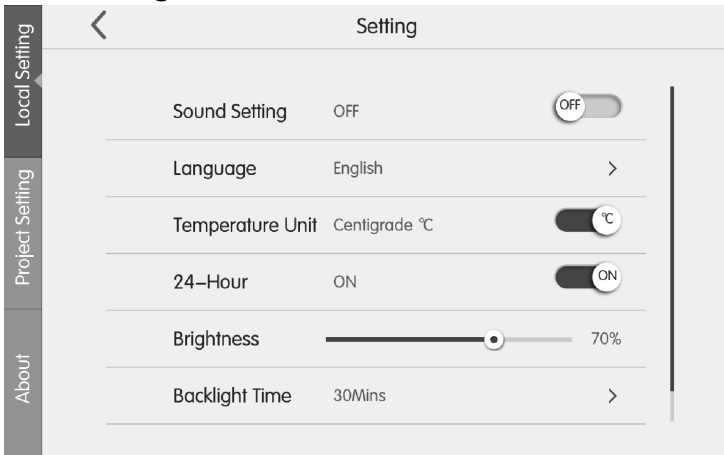

Figure 5-13 Setting Page

On the homepage, press  button to enter into the setting page.

Press the “Local Setting” button to switch to the setting options of the current unit.

Select the needed option at the left side column. Sliding up and down can turn over the page.

Set the corresponding content at the right side.

Local setting includes:

(1) Sound, temperature unit, time format, mutual exclusion

Press the button to select one kind of setting.

(2) Language

Press the button can select system language,such as English , Simplified Chinese ,Traditional Chinese,Spanish ,French ,Portuguese ,German , Turkish.

(3) Time setting

Set the date and time of the centralized controller system, can also set the VRF unit time if needed and Set the date and time of daylight saving time (DST).

(4) User password

Press the button can activate or inactivate user password.

When password is activated, it can be set or changed in 4~10 numbers or characters. Original password is blank.

Press the button ✓ to save the password.

Note: If user password is activated, user needs to input password to enter the control page when centralized controller is turned on or activated.

(5) Backlight setting

Pressing this button can set the timeout period of screen backlight. Screen will be shut off and the centralized controller will enter sleep mode when the timeout period is over.

Note:When centralized controller is in sleep mode, use can wake it up by touching any part of the touch screen or the touch button at the right bottom of the screen..

(6) Brightness

Pressing or dragging the sliding bar can adjust the backlight degree.

(7) Customer Service

User can set the name and phone number of the local customer service center for the convenience of acquiring immediate solutions and technical support.

Press the ✓ button to save the setting.

(8) View Selecting

Press the “View Selecting” button, User can select “VRF&CAC&Split”、”VRF Unit View” and “CAC&Split View”. Press the button ✓ to save the setting. Main Page keep the selected view style.

(9) Restore default settings

Press the “Reset” button to restore local setting, e-Control setting, group setting, schedule setting, names and icons of indoor units, and other relevant ex-factory default settings.

- 1) When switching between indoor network and outdoor network, or reset unit IP, restore the ex-factory setting for centralized controller.
- 2) After debugging for the centralized controller is finished, connect in to the network. If connect the centralized controller to the network during debugging process, it needs to restore the defaulted ex-factory setting.

5.6 About

On the home page, press  to enter into setting page.

Press the “About” button to switch to about page. The operation method is the same with that of the local setting.

On the page of about, user can view the information of the local unit, customer service information and other notices.

The Central controller can not control RAC and L-CAC in group.

NOTE CONCERNING PROTECTION OF ENVIRONMENT



This product must not be disposed of via normal household waste after its service life, but must be taken to a collection station for the recycling of electrical and electronic devices. The symbol on the product, the operating instructions or the packaging indicate such disposal procedures. The materials are recyclable in accordance with their respective symbols. By means of re-use, material recycling or any other form of recycling old appliances you are making an important contribution to the protection of our environment. Please ask your local council where your nearest disposal station is located.

INFORMATION CONCERNING USED REFRIGERANT MEDIUM

This unit is containing fluorinated gases included in the Kyoto protocol. The maintenance and the liquidation must be carried out by qualified personnel.

Type of refrigerant: R32

The quantity of the refrigerant: Please see the unit label.

The value GWP: 675 (1 kg R32 = 0,675 t CO₂ eq)

GWP = Global Warming Potential



Appliance filled with flammable gas R32.

In case of quality problem or other please contact your local supplier or authorized service center.

Emergency number: 112

PRODUCER

SINCLAIR CORPORATION Ltd.

16 Great Queen Street

WC2B 5AH London

United Kingdom

www.sinclair-world.com

This product was manufactured in China (Made in China).

REPRESENTATIVE

SINCLAIR Global Group s.r.o.

Purkynova 45

612 00 Brno

Czech Republic

TECHNICAL SUPPORT

SINCLAIR Global Group s.r.o.

Purkynova 45

612 00 Brno

Czech Republic

Tel.: +420 800 100 285 | Fax: +420 541 590 124

www.sinclair-solutions.com | info@sinclair-solutions.com



EN

For downloading manual for this product, please enter the model name at this link:

**SK**

Pre stiahnutie manuálu k tomuto produktu zadajte modelové označenie do nasledujúceho odkazu:

**HR**

Za preuzimanje priručnika za ovaj proizvod unesite naziv modela na ovu vezu:

**SL**

Za prenos navodil za uporabo tega izdelka, vnesite ime modela na tej povezavi:

**IT**

Per scaricare il manuale di questo prodotto, inserisci il nome del modello a questo link:

**CZ**

Pro stažení manuálu k tomuto produktu zadejte modelové označení do následujícího odkazu:

**DE**

Um das Handbuch für dieses Produkt herunterzuladen, geben Sie bitte den Modellnamen für diesen Link ein:

**HU**

Termék kézikönyvének letöltéséhez írja be a modell megnevezését az alábbi linkre:

**RU**

Чтобы загрузить руководство для этого продукта, введите обозначение модели по следующей ссылке:

**ES**

Para descargar el manual de este producto, ingrese la designación del modelo en el siguiente enlace:





sinclair

AIR CONDITIONING